















## FLAP WINGS

FLAP WINGS is a dramatic ceiling suspended design using FLAP GRANDE panels joined together with a back frame. The system comes equipped with the chrome-plated steel frame, aircraft cables and ceiling plates for ceiling suspension.



- Polyester internal padding with Snowsound technology, polyester covering in Trevira CS® fabric
- Single material and 100% recyclable
- Eco friendly - Greenguard Gold
- Durable, tackable double-sided surface
- Patented variable density composition
- Class A sound absorption with NRC 1.0 (ISO 354/ASTM C423/ISO 11654)
- Absorbs 94% of human speech frequencies
- Class A fire and smoke safety (UL 723/ASTM E84)
- CAL 133, 117 pass
- Sleek profile at only 1.4" thick
- Ceiling suspended
- Weight less than 10 lbs.
- CE certified for ceiling application

## FLAP WINGS - COMPLETE SET

STANDARD COLORS	COLOR	PART #	COLOR	PART #	COLOR	PART #	SPECIAL ORDER	COLOR	PART #		
	WHITE	40023046		OLIVE GREEN	40023054		BLUE	40023056		SUN YELLOW	40023051
	SILVER GRAY	40023047		DOVE GRAY	40023048		BLACK	40023057		BEIGE	40023050
	CARROT ORANGE	40023052		APPLE GREEN	40023055						
	CHARCOAL GRAY	40023049		RED	40023053						

**Special Order Colors Require:**

- Minimum order quantity
- Lead time up to 10-12 weeks

**Ceiling Kit includes:** (2) Flap Grande panels, (2) chrome ceiling plates, (3) steel cables, (3) adjustable cable locks and (1) hanging frame

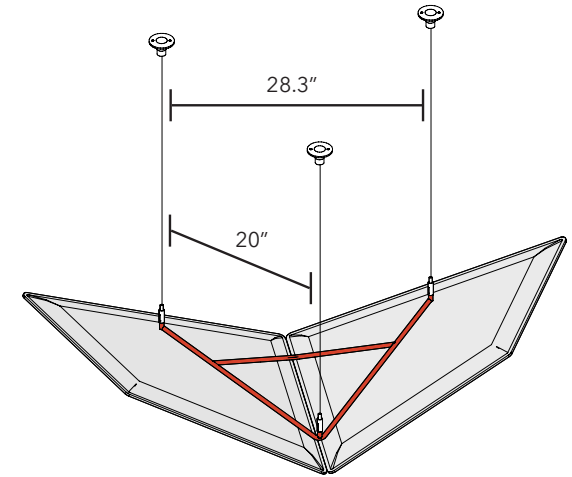

COMPLETE SYSTEM  
WEIGHT: 7.5 lbs.

