

NEW



### FLAT WALL / CEILING MOUNT

Equipped with chrome-plated metal plate for wall fixing. The panel can be tilted in any direction and can rotate 360 degrees. Despite their irregular shape, the panels can create innumerable combinations, including rectangles and squares.

### FLAT TOTEM

Divider made up of 12 FLAT panels set against each other and supported by a chrome-tubular steel structure mounted on a painted metal base. The panels, characterized by the plane front surface, can be tilted and rotated.



- Polyester internal padding with Snowsound technology, polyester covering in Trevira CS® fabric
- Single material and 100% recyclable
- Eco friendly - Greenguard Gold
- Durable, tackable double-sided surface
- Patented variable density composition
- Class A sound absorption with NRC 1.0 (ISO 354/ASTM C423/ISO 11654)
- Absorbs 94% of human speech frequencies
- Class A fire and smoke safety (UL 723/ASTM E84)
- CAL 133, 117 pass
- Sleek profile at only 1.4" thick
- Wall/ceiling mounted
- Free standing

## FLAT WALL / CEILING MOUNT KITS

NEW

### SMALL PAIR OF FLAT PANELS

15" x 15" x 29" PANEL SIZE, INCLUDES 3" BRACKETS

STANDARD COLOR	COLOR	PART #	PANELS	BRACKETS
	WHITE	40036259	2	2

\* For **direct surface mounting** on wall or ceiling.

### LARGE PAIR OF FLAT PANELS

15" x 30" x 30" PANEL SIZE, INCLUDES 3" BRACKETS

STANDARD COLOR	COLOR	PART #	PANELS	BRACKETS
	WHITE	40036258	2	2

\* For **direct surface mounting** on wall or ceiling.



Equipped with chrome-plated metal plate for wall fixing. The panel can be tilted in any direction and can rotate 360 degrees. Despite their irregular shape, the panels can create innumerable combinations, including rectangles and squares.

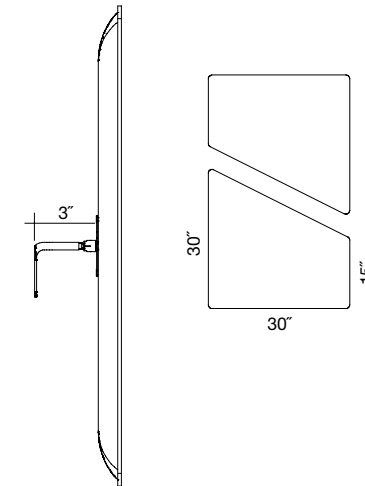
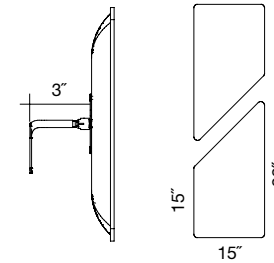

## FLAT TOTEM KIT

INCLUDES 12 FLAT PANELS AND STAND

STANDARD COLOR	COLOR	PART #	PANELS	STAND
	WHITE	40036260	12	1

Kit includes: 4 pairs (15" x 15" x 29") small panels and 2 pairs (15" x 30" x 30") large panels (12 panels total) with stand.

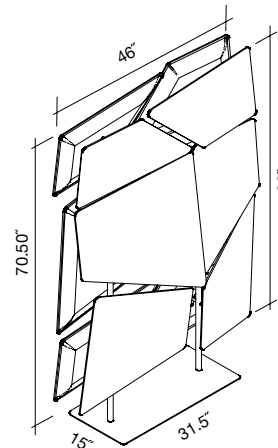

FLAT WALL/CEILING TYPICALS

NEW

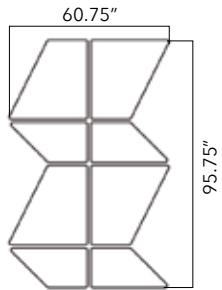

ITEM# 40036259: 2 FLAT SMALL (PAIR)  
ITEM# 40036258: 2 FLAT LARGE (PAIR)

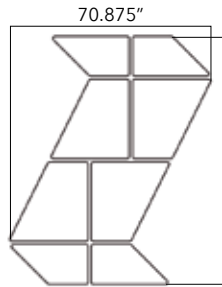

ITEM# 40036259: 2 FLAT SMALL (PAIR)  
ITEM# 40036258: 2 FLAT LARGE (PAIR)

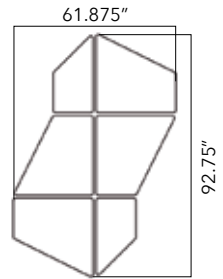

ITEM# 40036259: 1 FLAT SMALL (PAIR)  
ITEM# 40036258: 2 FLAT LARGE (PAIR)

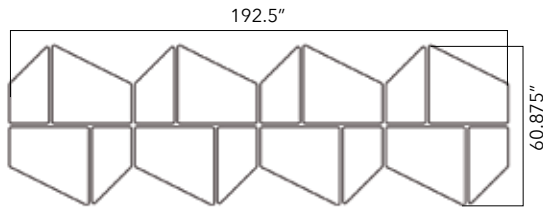

ITEM# 40036259: 4 FLAT SMALL (PAIR)  
ITEM# 40036258: 4 FLAT LARGE (PAIR)

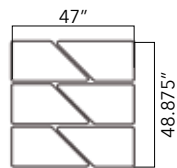

ITEM# 40036259: 3 FLAT SMALL (PAIR)

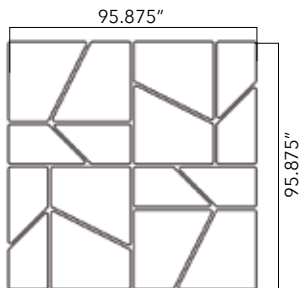

ITEM# 40036259: 4 FLAT SMALL (PAIR)  
ITEM# 40036258: 4 FLAT LARGE (PAIR)

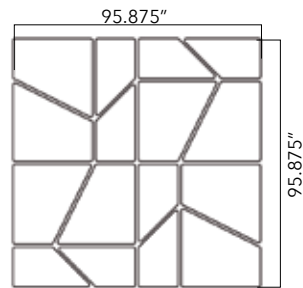

ITEM# 40036259: 4 FLAT SMALL (PAIR)  
ITEM# 40036258: 4 FLAT LARGE (PAIR)

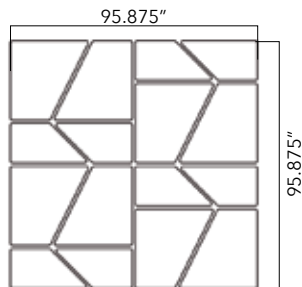

ITEM# 40036259: 4 FLAT SMALL (PAIR)  
ITEM# 40036258: 4 FLAT LARGE (PAIR)

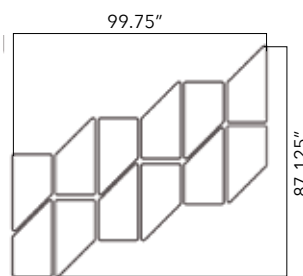

ITEM# 40036259: 6 FLAT SMALL (PAIR)



Angled inward/outward

NOTE: APPROXIMATE 2" GAP BETWEEN PANELS FOR SPACING



Flat



Rotated/ tilted

ITEM# 40036259: 3 FLAT SMALL (PAIR)  
ITEM# 40036258: 3 FLAT LARGE (PAIR)

\* MOUNTING BRACKETS INCLUDED FOR ALL TYPICALS SHOWN