

NEW















PLI OVER

The PLI OVER partitions and dividers with Snowsound technology are available in the self-supporting versions or with bases fitted with locking casters to allow utmost flexibility of movement.

- Polyester internal padding with Snowsound technology, polyester covering in Trevira CS® fabric
- Single material and 100% recyclable
- Eco friendly - Greenguard Gold
- Durable, tackable double-sided surface
- Patented variable density composition
- Class A sound absorption with NRC 1.0 (ISO 354/ASTM C423/ISO 11654)
- Absorbs 94% of human speech frequencies
- Class A fire and smoke safety (UL 723/ASTM E84)
- CAL 133, 117 pass
- Sleek profile at only 1.4" thick
- Free standing

PLI OVER - SIZE 47" x 47" PANEL ONLY

NEW

STANDARD COLORS	COLOR	PART #	SPECIAL ORDER	COLOR	PART #	SPECIAL ORDER	COLOR	PART #
	WHITE	40025042		CHALK WHITE	40025309		RUSTIC BRICK	40025291
	SILVER GRAY	40025043		BEIGE	40025313		OLIVE GREEN	40025318
	DOVE GRAY	40025044		SUN YELLOW	40025316		SLATE BLUE	40025299
	CHARCOAL GRAY	40025082		CARROT ORANGE	40025311		DARK TEAL	40025307
				RED	40025315			





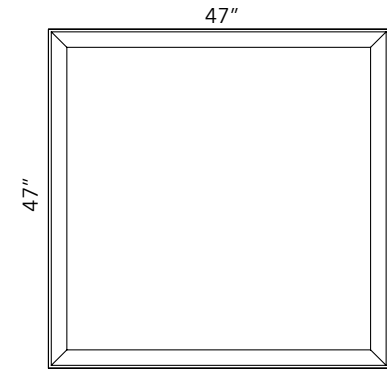







FOR ALL PANEL SIZES, SPECIAL ORDER COLORS REQUIRE:

- Minimum order quantity
- Lead time up to 10-12 weeks



**PLEASE SPECIFY PANEL STAND SEPARATELY
REFER TO PAGE: 78**

PLI OVER - SIZE 47" x 63" PANEL ONLY

STANDARD COLORS	COLOR	PART #	SPECIAL ORDER	COLOR	PART #	SPECIAL ORDER	COLOR	PART #
	WHITE	40025045		CHALK WHITE	40025310		RUSTIC BRICK	40025292
	SILVER GRAY	40025046		BEIGE	40025314		OLIVE GREEN	40025319
	DOVE GRAY	40025047		SUN YELLOW	40025317		SLATE BLUE	40025300
	CHARCOAL GRAY	40025080		CARROT ORANGE	40025312		DARK TEAL	40025308
				RED	40025284			

FOR ALL PANEL SIZES, SPECIAL ORDER COLORS REQUIRE:

- Minimum order quantity
- Lead time up to 10-12 weeks

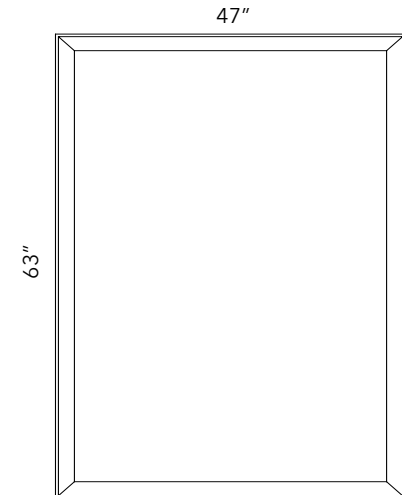

**PLEASE SPECIFY PANEL STAND SEPARATELY
REFER TO PAGE: 78**

PLEASE NOTE: Please call your local representative for special order color inquiries/ stock levels.

PLI OVER (FREE STANDING) - BASE STAND

NEW

PANEL SIZE	PART #	QTY	FINISH
BOTH SIZES	40025252	1 STAND	SILVER GRAY
BOTH SIZES	40025253	1 STAND	MATTE WHITE
BOTH SIZES	40025254	1 STAND	MATTE BLACK

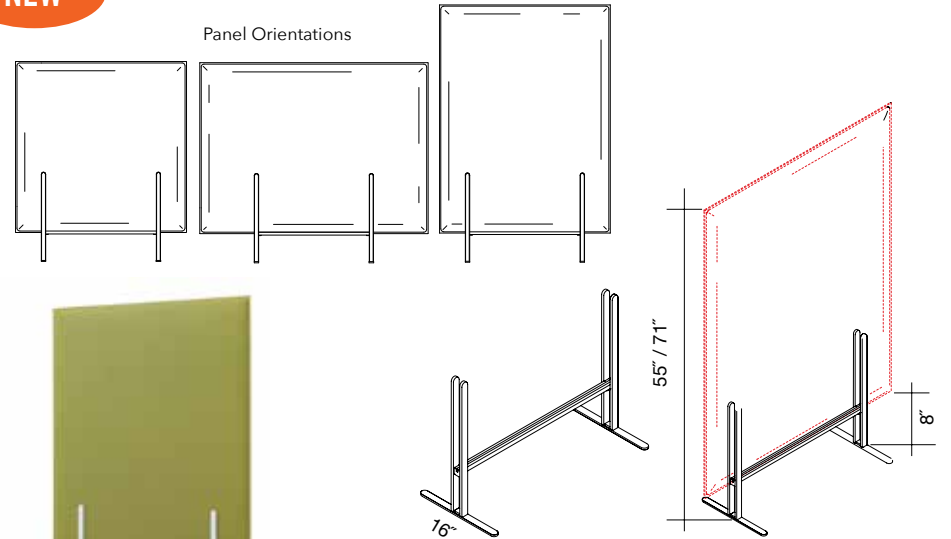

Silver Gray

Matte White

Matte Black



*Measurement is the panel orientation in the base from top of panel to floor (panel being placed horizontal or vertical).

PLI OVER (CASTERS) - STAND WITH LOCKING CASTERS

PANEL SIZE	PART #	QTY	FINISH
BOTH SIZES	40021133	1 STAND	SILVER GRAY
BOTH SIZES	40021134	1 STAND	MATTE WHITE
BOTH SIZES	40021135	1 STAND	MATTE BLACK

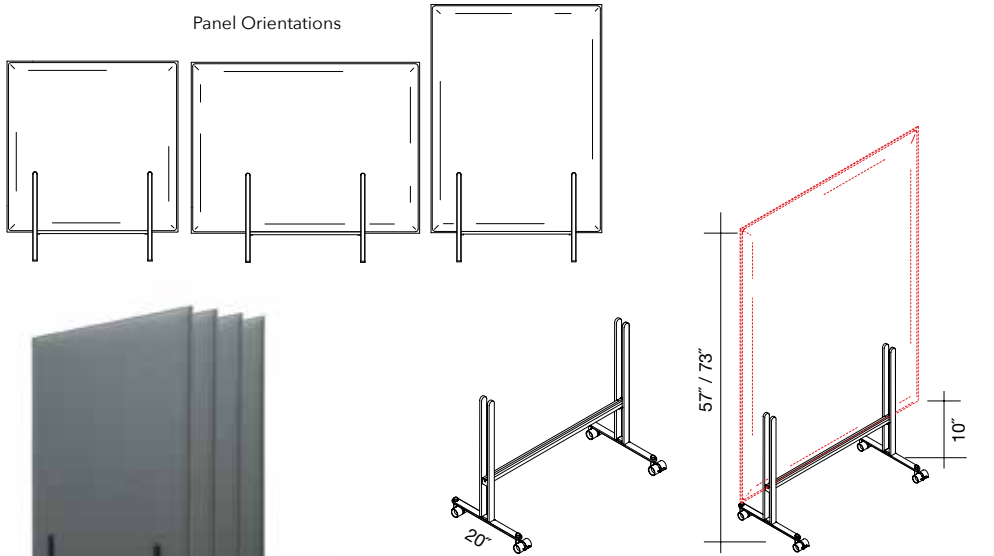

Silver Gray

Matte White

Matte Black



*Measurement is the panel orientation in the base from top of panel to floor (panel being placed horizontal or vertical).